

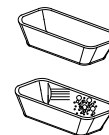

Dream-SP 180x80

PREDINSTALACIJA
PREINSTALLATION
VORINSTALLATION

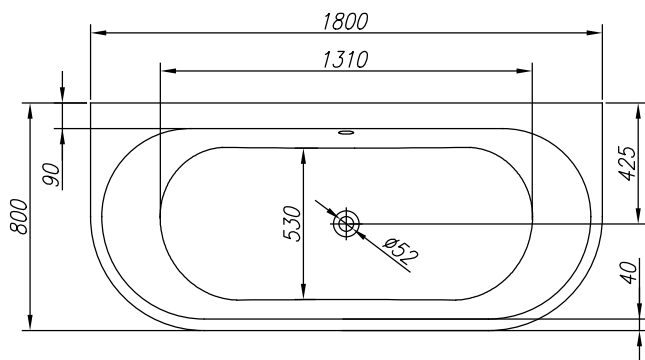
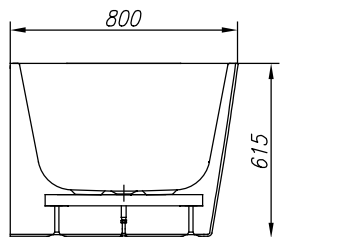
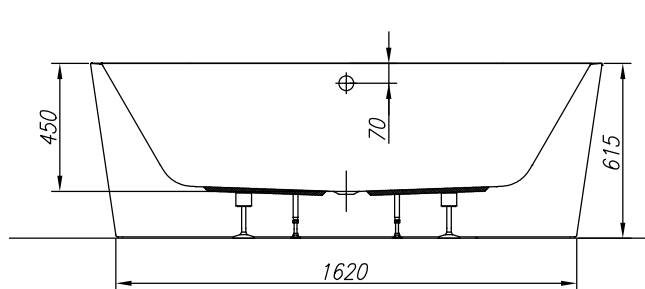

	<p>245 L VOLUMEN VOLUMEN VOLUME VOLUMEN</p>	<p>58 kg</p>	<p>TEŽA TEŽINA WEIGHT GEWICHT</p> <p>400 kg</p>	<p>MAX. OBREMENITEV MAX. OBTEREČENJE MAX. LOAD MAX. BELASTUNG</p>	<p>280 kg/m² OBREMENITEV TAL OBTEREČENJE PODA FLOOR LOAD BODENBELASTUNG</p>
--	--	---------------------	--	---	---

-  - Prostor za električni vodnik 3x2,5 mm², dolžine pribl. 1 m
- Mjesto za električni vodnik 3x2,5 mm², dužine cca. 1 m
- Spot for electrical cable 3x2,5 mm², length approx. 1 m
- Platz Stromkabel 3x2,5 mm², Länge ungefähr 1 m

-  - Prostor za električni vodnik 1x6 mm² za ozemljitev, dolžine pribl. 1,5 m
- Mjesto za električni vodnik 1x6 mm² za ozemljenje, dužine cca. 1,5 m
- Spot for electrical cable 1x6 mm² for earthing, length approx. 1,5 m
- Platz Stromkabel 1x6 mm² für Erdung, Länge ungefähr 1,5 m

-  - Priklop tople in hladne vode 1/2", min 0,2 Mpa, max 0,4 Mpa
- Priključak tople i hladne vode 1/2", min 0,2 Mpa, max 0,4 Mpa
- Connection of hot and cold water 1/2", min 0,2Mpa, max 0,4Mpa
- Anschluss Warm- und Kaltwasser 1/2", min 0,2 Mpa, max 0,4 Mpa

-  - Prostor za odtok Ø 50 mm
- Mjesto za odtok Ø 50 mm
- Drain spot Ø 50mm
- Abflussplatz Ø 50 mm

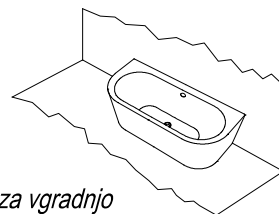

priporočilo za vgradnjo
preporuka za ugradnju
installation recommendation
Einbauempfehlung

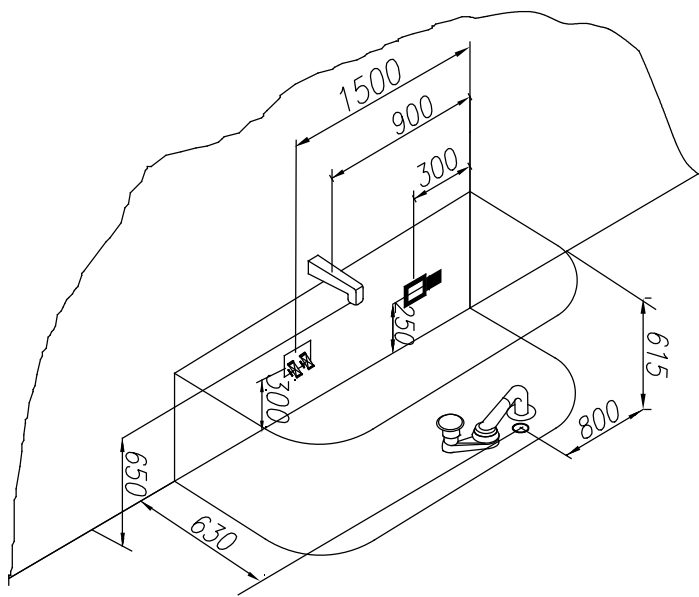

SP kopalna kad - navodilo za vgradnjo
SP kada - upute za ugradnju
SP bathtub - installation instructions
SP-Badewanne - Einbauanleitung

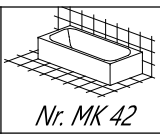

- | | | | | | | | | | |
|--|--|---|---|---|--|---|--|---|---|
|  | - MEŠALNI VENTIL TOPLA/HLADNA
- VENTIL ZA MIEŠANJE TOPLO/HLADNO
- MIXING VALVE HOT/COLD
- MISCHVENTIL WARM/KALT |  | - PREKLOPNIK ROČNA PRHA/IZLIV
- PREKIDAČ ZA RUČNI TUŠ/IZLJEV
- HAND SHOWER/SPOUT SELECTOR SWITCH
- SCHALTER FÜR HANDBRAUSE/AUSLAUF |  | - ROČNA PRHA
- RUČNI TUŠ
- HAND SHOWER
- HANDBRAUSE |  | - IZLIV
- IZLJEVNIK
- SPOUT
- AUSLAUF |  | - IZLIV NA PRELIVNI GARNITURI
- IZLJEV NA PRELJEVNOM SETU
- SPOUT ON THE OVERFLOW SET
- AUSLAUF AN DER ÜBERLAUF GARNITUR |
|--|--|---|---|---|--|---|--|---|---|

- OPCIJA ENOROČNA ARMATURA WATERFALL
- OPCIJA JEDNORUČNA ARMATURA WATERFALL
- OPTION ONE HAND FITTING WATERFALL
- MÖGLICHKEIT EINWEG-ARMATUR WATERFALL

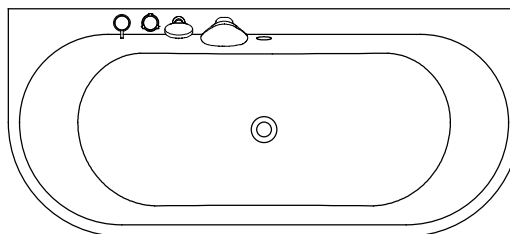
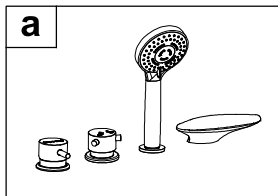

- OPCIJA ENOROČNA ARMATURA GEYSER
- OPCIJA JEDNORUČNA ARMATURA GEYSER
- OPTION ONE HAND FITTING GEYSER
- MÖGLICHKEIT EINWEG-ARMATUR GEYSER

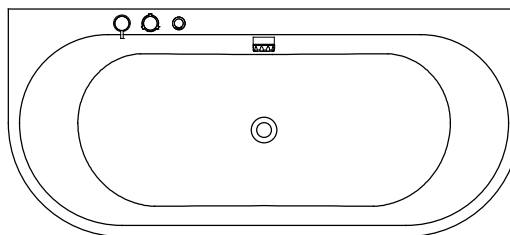
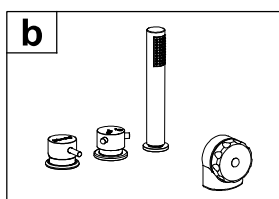

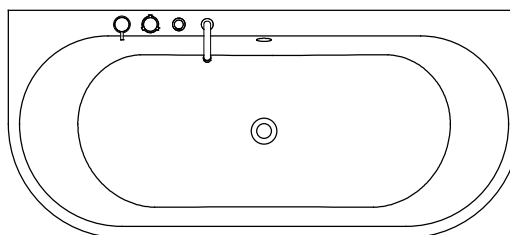
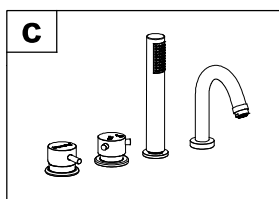

- OPCIJA ENOROČNA ARMATURA RAINDROP
- OPCIJA JEDNORUČNA ARMATURA RAINDROP
- OPTION ONE HAND FITTING RAINDROP
- MÖGLICHKEIT EINWEG-ARMATUR RAINDROP

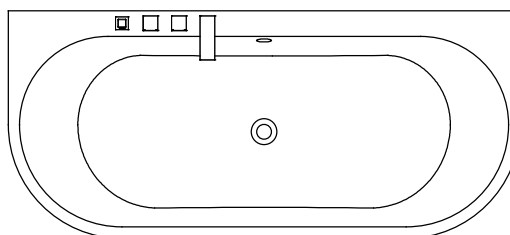
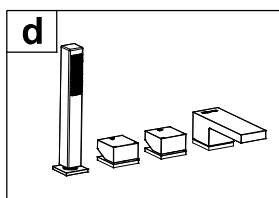

- OPCIJA ENOROČNA ARMATURA STREAM (CHR / BLACK)
- OPCIJA JEDNORUČNA ARMATURA STREAM (CHR / BLACK)
- OPTION ONE HAND FITTING STREAM (CHR / BLACK)
- MÖGLICHKEIT EINWEG-ARMATUR STREAM (CHR / BLACK)

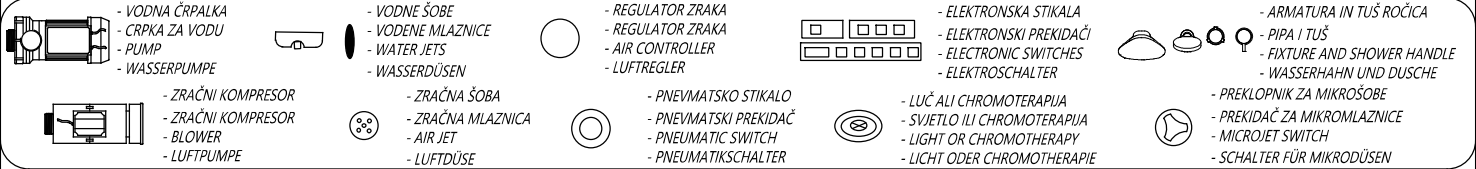

TEŽA
TEŽINA
WEIGHT
GEWICHT

68 kg

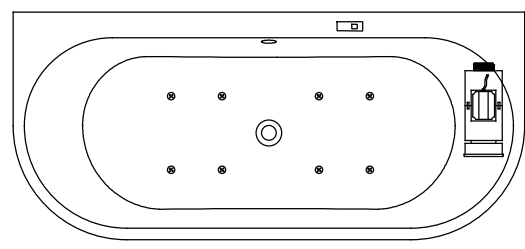

ZRAČNI MASAŽNI SISTEM
 - ZRAČNI KOMPRESOR P=800W
 - ELEKTRONSKO STIKALO
 - 8 ZRAČNIH ŠOB

ZRAČNI MASAŽNI SISTEM
 - ZRAČNI KOMPRESOR P=800W
 - ELEKTRONSKI PREKIDAČ
 - 8 ZRAČNIH MLAZNICA

AIR MESSAGE SYSTEM
 - BLOWER P=800W
 - ELECTRONIC SWITCH
 - 8 AIR JETS

LUFT MASSAGESYSTEM
 - LUFTPUMPE P = 800 W
 - ELEKTROSCHALTER
 - 8 LUFTDÜSEN

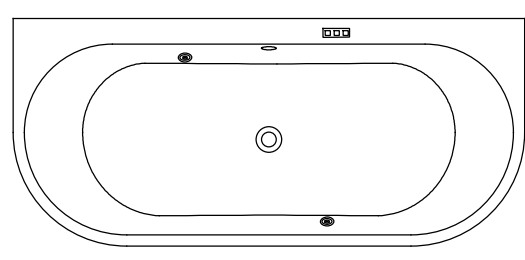

OPCIJE
 - OPCIJA CHROMOTERAPIJA



OPCIJE
 - OPCIJA CHROMOTERAPIJA

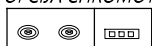

OPTIONS
 - OPTION CHROMOTHERAPY

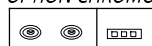

MÖGLICHKEITEN
 - MÖGLICHKEIT CHROMOTHERAPIE

